

Simple Virtual Slip Force Sensor for Walking Biped Robots

Iyad Hashlamon

Faculty of Engineering and Natural Sciences
Sabanci University
Tuzla, Istanbul, Turkey
hashlamon@sabanciuniv.edu

Kemalettin Erbatur

Faculty of Engineering and Natural Sciences
Sabanci University
Tuzla, Istanbul, Turkey
erbatur@sabanciuniv.edu

Abstract—This paper presents a novel simple Virtual Slip Force Sensor (VSFS) for a walking biped. Biped walking stability is critical and they tend to lose it easily in real environments. Among the significant aspects that affect the stability is the availability of the required friction force which is necessary for the robot not to slip. In this paper we propose the use of the virtual sensor to detect the slip force. The design structure of the VSFS consists of two steps, in the first step it utilizes the measured acceleration of the center of mass (CoM) and the ZMP signals in the simple linear inverted pendulum model (LIPM) to estimate the position of the CoM, and in the second step the Newton law is employed to find the total ground reaction force (GRF) for each leg based on the position of CoM. Then both the estimated force and the measured force from the sensors assembled at the foot are used to detect the slip force. The validity of the proposed estimation method was confirmed by simulations on 3D dynamics model of the humanoid robot SURALP while walking. The results are promising and prove themselves well.

Index Terms— Virtual sensor, ground reaction forces, inertial measurement unit (IMU), ZMP.

I. INTRODUCTION

Humanoid robots have a suitable structure for tasks in the human environment, this explains why they attracted a great attention of many researchers. Although stable walking trajectories [1-4] that satisfy the zero moment point (ZMP) [5] stability criteria to have stable walking are required, the robot may tend to tip over in real life. This is because of the environmental uncertainty and change. Among the parameters that affect the stable walking are the contact parameters between the robot feet and the ground. These parameters can be summarized in the friction and the slip forces. The friction force has a significant importance, it determines the maximum acceleration and deceleration and hence the maximum forces allowed to be applied to the robot [6, 7]. They can be measured by sensors embedded in the feet of the humanoid robot as in [8, 9]. However, slip forces are unmeasured and may cause the robot to tip over. Generally the slip force can be defined as the difference between the total system forces and the friction forces. Although it is significant to study these forces, a few studies were reported. In the biped walking, it is often assumed the no slipping case, in other words, the coefficient of friction is either considered to be very high such

that the slipping never happens or accurately known which is impractical.

Slipping observer is introduced in [10] where the slip force is calculated as the difference between the desired reaction force and the measured one. The desired force is calculated using the 3D linear inverted pendulum model with known ZMP. However, the desired reaction force does not include the external and inertial forces, thus it is not necessarily that the difference is due to higher desired reaction forces, and the slip may occur even the desired reaction force is less than the measured.

Slipping is estimated using the friction force too. Friction force estimation based on estimating the coefficient of friction is introduced in [11] [12]. They depend on using friction models and estimators. This method has the advantage over the slipping observer in a way it doesn't need the robot to slip. However it is difficult to model the friction because it changes with time due to the environmental changes like temperature, surfaces, and wear. And it depends on the dynamic characteristics of the system which have uncertainty [13].

Developing a software sensor that utilizes the system dynamic model is a solution for force estimation. It operates in parallel to the real system and utilizes the same input to reconstruct the required signal. However, obtaining the dynamic model for complicated systems such as the humanoid robot is a challenge due to the many degrees of freedom, coupling effects, nonlinear dynamics, and parameter and environment uncertainty [1]. An alternative solution is to use virtual sensors [14] based on simple mathematical models, this type of sensors utilizes some measured signals to reconstruct the required signals.

In this paper, a novel VSFS is designed and proposed to estimate the slip force for walking bipeds. The VSFS considers the external and inertial forces rather than the desired forces and doesn't depend on friction force models. It is designed in two steps: estimating the center of mass (CoM) position which is reported by the author in [15] where the LIPM is employed and the measured ZMP and acceleration from the inertial measurement unit IMU fixed at the CoM are utilized through Kalman filter. In the second step the total reaction force at each leg is calculated using Newton law. Then these forces are compared to the measured ones to find the slip force. Thus the inputs for the VSFS are the measured

acceleration, ZMP and the measured reaction force while the output is the slip force at each leg.

The rest of the paper is organized as follows: Section 2 describes the virtual slip force sensor design. Section 3 introduces the simulation platform and presents the simulation results. The paper conclusion is in Section 4.

II. VIRTUAL SLIP FORCE SENSOR VSFS

The VSFS model structure as shown in Fig 1 consists of two models: the linear inverted pendulum model (LIPM) and the Newton-Euler model. The LIPM function is to estimate the CoM position, while the Newton-Euler model is to estimate the ground reaction forces. The measured force represents the friction force.

a) CoM position estimation

The LIPM dynamics in Eq(1) are used to form the process dynamics of the estimation as in

$$\ddot{c} = \frac{g}{z_c}(c - p) \quad (1)$$

where Z_c is the constant height of CoM, c is the CoM position, g is the gravity acceleration (9.806 m/s^2), and p is the ZMP trajectory. The value of p can be measured by modifying Eq(1) as

$$p = c - \frac{z_c}{g} \ddot{c} \quad (2)$$

or by using sensors attached to the robot leg feet such as force sensors [9, 16] or ZMP sensors [17]. Let the measured ZMP using the later method be p^f , then in the ideal case, both p and p^f are the same, accordingly, Eq(1) can be written in terms of p^f in discrete form as

$$\ddot{c}_k = T \frac{g}{z_c} (\dot{c}_{k-1} - \dot{p}_{k-1}^f) + \ddot{c}_{k-1} \quad (3)$$

where

$$\dot{p}_{k-1}^f = \frac{p_k^f - p_{k-1}^f}{T} \quad (4)$$

T is the sampling time, and k is the time instant. However, due to modeling error, noise, and disturbance an error between them exists, this error in the ZMP “ p^{err} ” is expressed as

$$p^{err} = p^f - p \quad (5)$$

And simplified in terms of previous known states as in Eq (6)

$$p_k^{err} = -c_{k-1} + p_{k-1}^f + \frac{z_c}{g} \ddot{c}_{k-1} \quad (6)$$

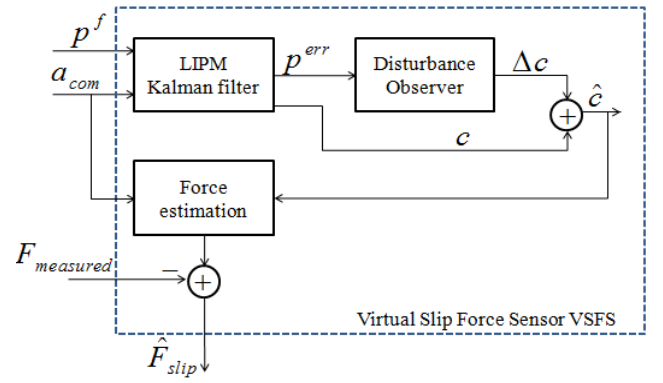

Fig 1 Virtual Slip Force Sensor (VSFS) structure

Equation(3) and Eq(4) form the process model required for the basic structure of Kalman filter. Considering the acceleration a_{com} as the measurement vector to be used in the correction part of Kalman filter, then the state space model used in the filter is

$$\begin{aligned} x_k &= Ax_{k-1} + Bu_k + w_k \\ Y_k &= Cx_k + v_k \\ z_k &= a_{com} \end{aligned} \quad (7)$$

where:

$$\begin{aligned} x &= [c \quad \dot{c} \quad \ddot{c} \quad p^f]^T, u = \dot{p}_{k-1}^f \\ A &= \begin{bmatrix} 1 & T & 0.5T^2 & 0 \\ 0 & 1 & T & 0 \\ 0 & \frac{g}{z_c}T & 1 & 0 \\ 0 & 0 & 0 & 1 \end{bmatrix}, B = \begin{bmatrix} 0 \\ 0 \\ -\frac{g}{z_c}T \\ T \end{bmatrix}, \end{aligned}$$

and

$$C = [0 \quad 0 \quad 1 \quad 0],$$

w and v represent the process and the measurement noises respectively. They are considered Gaussian processes with covariance's Q and R as

$$\begin{aligned} w &\sim N(0, Q) \\ v &\sim N(0, R) \end{aligned}$$

The estimated error in Eq(6) is composed of position or offset error and acceleration error. They can be separated based on the frequency band using two low pass filters with different frequencies [18, 19]. The time constants are selected such that $\tau_1 > \tau_2$. The offset error Δc and the acceleration error $\Delta \ddot{c}$ are obtained as shown in Fig 2.

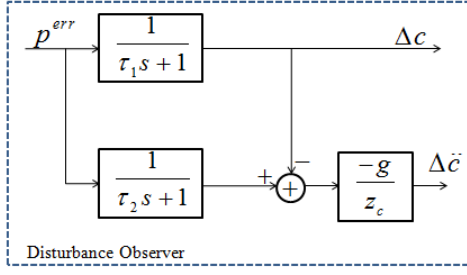

Fig 2. Disturbance observer

The acceleration error can be considered as an external force exerted on the biped and causes this acceleration. Then the estimated and corrected CoM position \hat{c} is

$$\hat{c} = c + \Delta c \quad (8)$$

b) Reaction force estimation

The force magnitude on each leg depends on the location of \hat{c} . Assuming the slow walking and neglecting the swinging leg and arms inertial forces, the forces for each leg are calculated using

$$\begin{aligned} \hat{F}_L &= \frac{1}{2}(1+\alpha)m\ddot{c}, \\ \hat{F}_R &= \frac{1}{2}(1-\alpha)m\ddot{c} \end{aligned} \quad (9)$$

Where

$$\alpha = \frac{\hat{c}_y}{c_{y\max}}, \quad -1 \leq \alpha \leq 1 \quad (10)$$

$$\begin{cases} \alpha = 0 & F_L = F_R \\ \alpha > 0 & F_L > F_R \\ \alpha < 0 & F_L < F_R \end{cases}, \quad (11)$$

And

$$\begin{cases} \alpha = 1 & \text{if } \alpha > 1 \\ \alpha = -1 & \text{if } \alpha < -1 \end{cases} \quad (12)$$

where, m is the robot mass, \hat{F}_R and \hat{F}_L are the estimated reaction forces at the right and left feet respectively. \hat{c}_y is the estimated position of the CoM in the y-direction (lateral) and $c_{y\max}$ is the maximum of c_y obtained from the desired value or by recording the maximum of \hat{c}_y when the single support phase starts.

c) Slip definition

In this work, the slip is defined as the case when the friction force between the foot and the ground is not enough to make the relative velocity between them zero in the full contact condition. The difference between the friction force and the

applied forces is defined as the slip force. The friction force is measured from force sensors assembled in the foot sole of the robot leg. The applied forces are estimated based on the acceleration measured from an accelerometer assembled at the CoM, and the inertial forces from the moving arms, head, and the swinging leg.

In the ideal situation, where no slipping exists and the foot is in full contact, the resultant force acting on the foot must be zero, i.e.

$$\hat{F} + F_{inertia} - F_{meas} = 0 \quad (13)$$

Where F_{meas} is the measured forces, \hat{F} is the estimated forces in the previous section $\hat{F} = [\hat{F}_R^T \quad \hat{F}_L^T]^T$, and $F_{inertia}$ is the former mentioned inertial forces.

However, when the slip occurs, Eq(13) is modified by adding the slip force F_{slip} as

$$\hat{F}_h + F_{inertia,h} - F_{meas,h} - F_{slip} = 0 \quad (14)$$

Which yields that the slip force is

$$F_{slip} = \hat{F}_h + F_{inertia,h} - F_{meas,h} \quad (15)$$

The subscript h indicates the horizontal components of the forces that are parallel to the contact surface.

III. SIMULATION RESULTS

The simulations are carried on 12 degrees of freedom (DOF) biped model. It consists of two 6-DOF legs and a trunk connecting them. Three joint axes are positioned at the hip, two joints are at the ankle and one at the knee (Fig 3). The numerical values of the parameters (Table I) are taken to match our experimental humanoid robot SURALP (Sabanci University Robotics Research Laboratory Platform) [20]. The details of contact modeling and simulation algorithm are in [21]. The coordinate frames are shown in Fig 4. All the measurements and calculation are in the world frame. The transformation is done using the rotational matrix obtained by the author in [22]. Kalman filter parameters are listed in Table II.

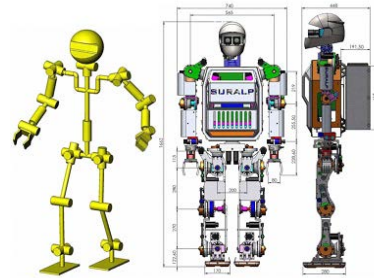

Fig 3. The kinematic arrangement of SURALP

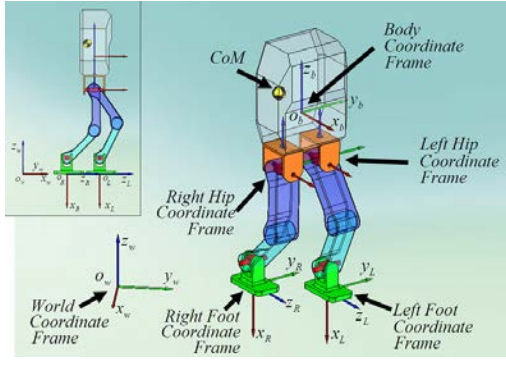

Fig 4. Coordinate systems . o_w and o_b stand for the origins of the world and body coordinate frames, respectively. The foot coordinate frames are fixed to the foot soles.

Table I: Robot Parameters

Parameter	Value
Upper leg length	280mm
Lower leg length	270mm
Sole-ankle distance	124mm
Foot dimensions	240mm×150mm
Upper arm length	219mm
Lower arm length	255mm
Robot weight	114 kg

Table II: simulation parameters

Parameter	value
Q	10^{-10}
R	10^{-4}
T	0.001

The walking trajectory of the biped CoM is in Fig 3. The corresponding estimated slip forces in the x -direction for both of the legs are depicted in Fig 6 and Fig 7. In the Fig 7 the single support at the time instant 8 takes place for 0.6 sec, the double support for 0.9 sec, then again single support for 0.6 sec, and so on. At the time instant 10, the robot body arrives to its position and doesn't move.

In these simulations, the walking is assumed slow, so that the inertial forces of the moving leg are neglected. The results are based on the difference between the estimated forces using the IMU and the measured forces as expressed in the world coordinate frame. As depicted in the figures, The VSFS is able to use the IMU and force sensors readings through simple models to detect and estimate the slip force. These estimates should be used with a control law to keep the robot stability.

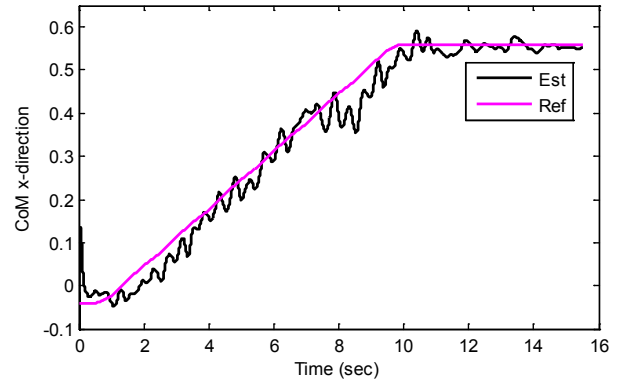

Fig 5. CoM position in the x -direction. Est is the estimated and Ref is the reference trajectory.

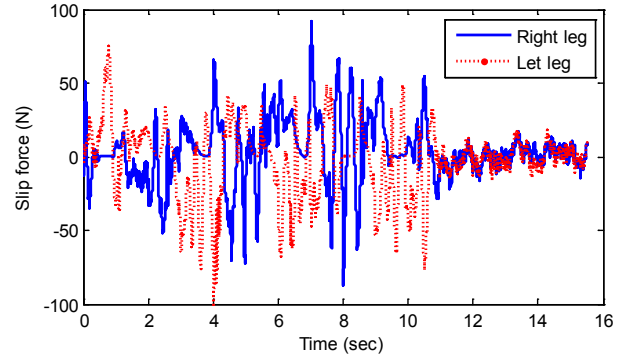

Fig 6. Slip force

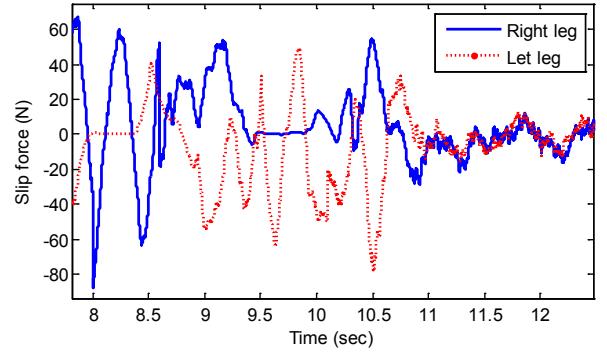

Fig 7. Zoomed in Fig 4

IV. CONCLUSION AND FUTURE WORK

A method of designing virtual slip force sensor for a walking biped is proposed. It is based on estimating the applied forces on each leg of the biped. Then the slip force is the difference between the estimated force and the measured one. The results show the ability of the proposed virtual sensor to estimate the slip force.

The research on this method is still in progress, the aim is to build a VSFS that can predict the changes in the coefficient of friction to predict the slip phenomena one step ahead. This will be fruitful to be used in the feedback of the control laws to preserve the stability of the robot in case of walking surface parameters change.

REFERENCES

- [1] U. Seven, T. Akbas, K. Fidan, and K. Erbatur, "Bipedal robot walking control on inclined planes by fuzzy reference trajectory modification," *Soft Computing*, pp. 1-18, 2012.
- [2] U. Seven, T. Akbas, K. C. Fidan, M. Yilmaz, and K. Erbatur, "Humanoid robot walking control on inclined planes," in *IEEE International Conference on Mechatronics (ICM)*, 2011 pp. 875-880.
- [3] K. Erbatur and O. Kurt, "Natural ZMP Trajectories for Biped Robot Reference Generation," *Ieee Transactions on Industrial Electronics*, vol. 56, pp. 835-845, Mar 2009.
- [4] K. Erbatur and U. Seven, "Humanoid gait synthesis with moving single support ZMP trajectories," in *Proceedings of the 13th Iasted International Conference on Robotics and Applications/Proceedings of the Iasted International Conference on Telematics*, K. Schilling, Ed. Anaheim: Acta Press Anaheim, 2007, pp. 95-100.
- [5] M. Vukobratovič and B. Borovac, "Zero-moment point -thirty five years of its life," *International Journal of Humanoid Robotics (IJHR)*, vol. 01, pp. 157-173, 2004.
- [6] B. Stephens and C. Atkeson, "Modeling and control of periodic humanoid balance using the Linear Biped Model," in *9th IEEE-RAS International Conference on Humanoid Robots*, 2009, pp. 379-384.
- [7] C. Yang and Q. Wu, "Effects of gravity and friction constraints on bipedal balance control," in *Proceedings of 2005 IEEE Conference on Control Applications*, 2005. CCA 2005, pp. 1093-1098.
- [8] G. Kinoshita, T. Kimura, and M. Shimojo, "Dynamic sensing experiments of reaction force distributions on the sole of a walking humanoid robot," in *Proceedings of International Conference on Intelligent Robots and Systems*, 2003, pp. 1413-1418.
- [9] K. Nishiwaki, Y. Murakami, S. Kagami, Y. Kuniyoshi, M. Inaba, and H. Inoue, "A six-axis force sensor with parallel support mechanism to measure the ground reaction force of humanoid robot," in *Proceedings of IEEE International Conference on Robotics and Automation*, 2002, pp. 2277-2282.
- [10] K. Kaneko, F. Kanehiro, S. Kajita, M. Morisawa, K. Fujiwara, K. Harada, and H. Hirukawa, "Slip observer for walking on a low friction floor," in *IEEE/RSJ International Conference on Intelligent Robots and Systems. (IROS 2005)*. 2005, pp. 634-640.
- [11] S. Roosen, "Ground-Contact Friction Estimation and Slip Prevention in Bipedal Robots," Master thesis, University Of Melbourne, 2012.
- [12] C. J. Tsaprounis and N. A. Aspragathos, "A linear differential formulation of friction forces for adaptive estimator algorithms," *Robotica*, vol. 19, pp. 407-421, 2001.
- [13] B. Bona and M. Indri, "Friction Compensation in Robotics: an Overview," in *Decision and Control, 2005 and 2005 European Control Conference. CDC-ECC '05. 44th IEEE Conference on*, 2005, pp. 4360-4367.
- [14] G. Heredia and A. Ollero, "Virtual Sensor for Failure Detection, Identification and Recovery in the Transition Phase of a Morphing Aircraft," *Sensors*, vol. 10, pp. 2188-2201, 2010.
- [15] I. Hashlamon and K. Erbatur, "Center of Mass States and Disturbance Estimation for a Walking Biped" in *IEEE International Conference on Mechatronics, ICM 2013, Vicenza (Italy)*. 2013, pp. 248-253.
- [16] P. Sardain and G. Bessonnet, "Forces acting on a biped robot. Center of pressure-zero moment point," *IEEE Transactions on Systems, Man and Cybernetics, Part A: Systems and Humans*, vol. 34, pp. 630-637, 2004.
- [17] M. Shimojo, T. Araki, A. Ming, and M. Ishikawa, "A ZMP sensor for a biped robot," in *Proceedings 2006 IEEE International Conference on Robotics and Automation. ICRA 2006*, pp. 1200-1205.
- [18] T. Sato, S. Sakaino, and K. Ohnishi, "Parameter design for ZMP disturbance observer of biped robot," in *34th Annual Conference of IEEE on Industrial Electronics*, 2008, pp. 1650-1655.
- [19] T. Sato and K. Ohnishi, "ZMP disturbance observer for walking stabilization of biped robot," in *IEEE International Workshop on Advanced Motion Control*, 2008, pp. 290-295.
- [20] K. Erbatur, U. Seven, E. Taskiran, O. Koca, M. Yilmaz, M. Unel, G. Kiziltas, A. Sabanovic, and A. Onat, "SURALP: A New Full-Body Humanoid Robot Platform," *2009 Ieee-Rsj International Conference on Intelligent Robots and Systems*, pp. 4949-4954, 2009.
- [21] K. Erbatur and A. Kawamura, "A new penalty based contact modeling and dynamics simulation method as applied to biped walking robots," in *Proc. 2003 FIRA World Congress, Vienna, Austria*, 2003.
- [22] I. Hashlamon and K. Erbatur, "Experimental verification of an orientation estimation technique for autonomous robotic platforms," Master thesis, Sabanci University, Istanbul, 2010.